

VPFlowTerminal

User manual
© 2017 Van Putten Instruments BV

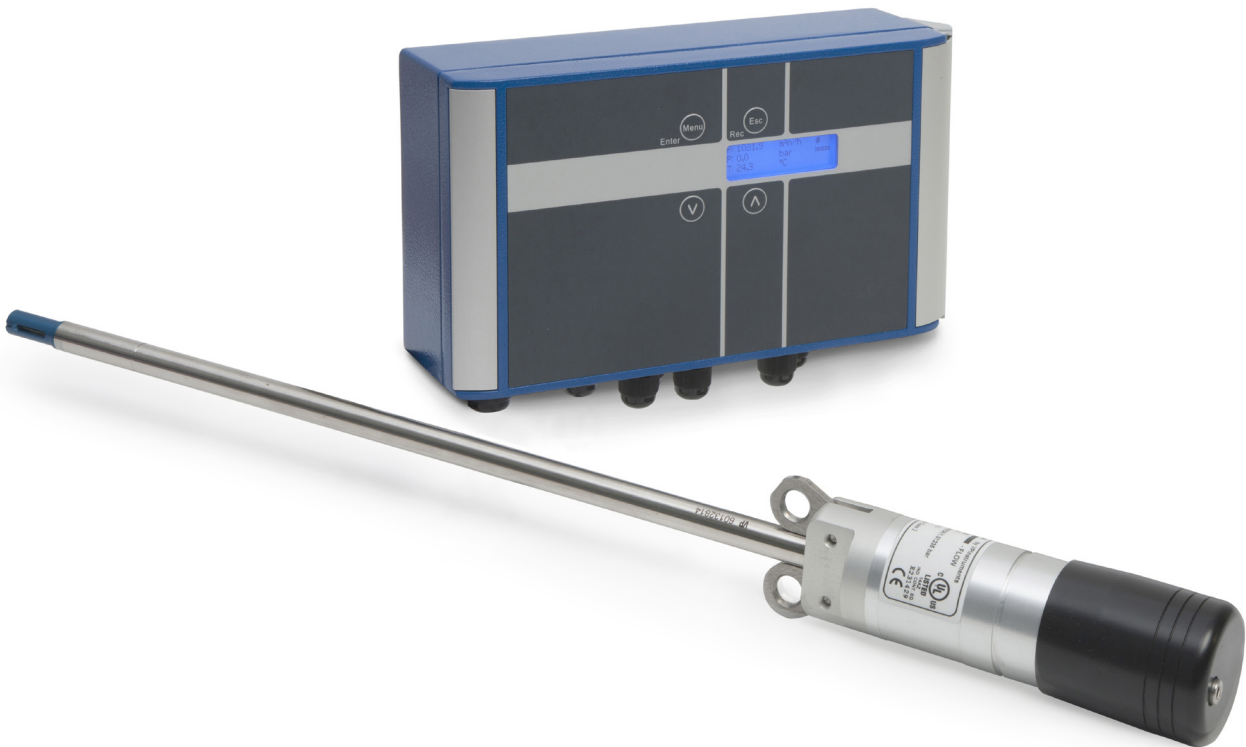

VPFlowTerminal

© 2017 Van Putten Instruments BV

All rights reserved. No parts of this document may be reproduced in any form or by any means - graphic, electronic, or mechanical, including photocopying, recording, taping, or information storage and retrieval systems - without the written permission of the publisher.

Products that are referred to in this document may be either trademarks and/or registered trademarks of the respective owners. The publisher and the author make no claim to these trademarks.

While every precaution has been taken in the preparation of this document, the publisher and the author assume no responsibility for errors or omissions, or for damages resulting from the use of information contained in this document or from the use of programs and source code that may accompany it. In no event shall the publisher and the author be liable for any loss of profit or any other commercial damage caused or alleged to have been caused directly or indirectly by this document.

Creation date: 16-02-2017 in Delft

Publisher





*Van Putten Instruments BV
Buitenwatersloot 335
2614 GS Delft
The Netherlands*

*This document is available in:
English, English (UK)*

Table of Contents

1 Warning - Read this first	4
2 Introduction	5
3 Product overview	6
4 Quick start	7
5 Mechanical installation	8
6 Electrical connections	9
1 Connections	9
2 Electrical overview	9
3 Connection to mains	10
4 VPFlowScope connections.....	11
5 Analog inputs	11
6 Ethernet converter	12
7 Schemes	13
7 Display	14
1 Display status icons	14
2 LCD display	14
3 Data Logger	14
4 Keypad	15
5 Menu	15
8 VPStudio software	18
9 Service	19
1 Software and firmware updates.....	19
2 Calibration interval	19
3 Service subscriptions	19
10 Specifications	20
11 Order information and accessories	21
12 Appendix A - Connection examples	22
13 Appendix B - Zero and Span calculation	23

1 Warning - Read this first

	<p>Compressed gasses can be dangerous! Please familiarize yourself with the forces under pressurized conditions. Respect the local guidelines and regulations for working with pressurized equipment.</p>
	<p>Gas flow through pipes follows certain physical laws. These physical laws have serious consequences for the installation requirements. Familiarize yourself with the basic physical laws of flow measurement, to make sure that the product is installed correctly. Always make sure that upstream length, downstream length, flow, pressure, temperature and humidity conditions are within specifications</p>
	<p>Precision instruments need maintenance. Check your flow meter regularly and make sure it remains clean. When polluted, gently clean the sensor using demineralised water or cleaning alcohol. Precision instruments need regular re-calibration. To keep your VPFlowTerminal and attached flow meter in best shape, it needs recalibration. We advice annual recalibration.</p>
	<p>Not intended for fiscal metering or billing. Our flow meters are not certified for fiscal metering. Laws on fiscal metering and billing may vary per country or state.</p>
	<p>Do not overestimate the results. VPIstruments does not take any responsibility for the correctness of measurement results under field conditions. The practical measurement uncertainty of a flow meter in the field may vary, depending on how well it is installed, due to the nature of gas flow. The piping table provides guidelines on how to optimize the field accuracy. Our products are not intended to be used as a single means to determine compressor capacity.</p>
	<p>Feedback leads to product improvement. Please share your experience with us, as we are continuously improving our products in our commitment to quality, reliability and ease of use. Let us know via sales@vpinstruments.com!</p>

2 Introduction

Dear customer,

Thank you for purchasing the VPFlowTerminal. The VPFlowTerminal is a remote display for the VPFlowScope product family, has a built-in data logger and provides input for 4 analog inputs.

Great products deserve great user manuals. We have done our best to make this user manual as complete as possible. New users, please read it carefully to familiarize yourself with our products. Experienced users can check out the [Quick start chapter](#).

This manual is dedicated to:

VPT.5110.000

3 Product overview

The VPFlowTerminal is intended as remote display. It provides local read out on locations where the VPFlowScope is placed in high or unreachable locations. The display provides read out for flow, pressure, temperature, totalizer and up to 4 analog inputs.

To make the VPFlowTerminal even more complete, a 2 Million point data logger and Modbus to Ethernet converter are integrated.

The VPFlowTerminal can be used in combination with the:

- VPFlowScope probe Thermal Mass
- VPFlowScope in-line Thermal Mass
- VPFlowScope probe Differential Pressure

Analog input options:

- VPLog-I current sensor
- Dew point sensor
- Pressure sensor
- Any other 4..20mA sensor

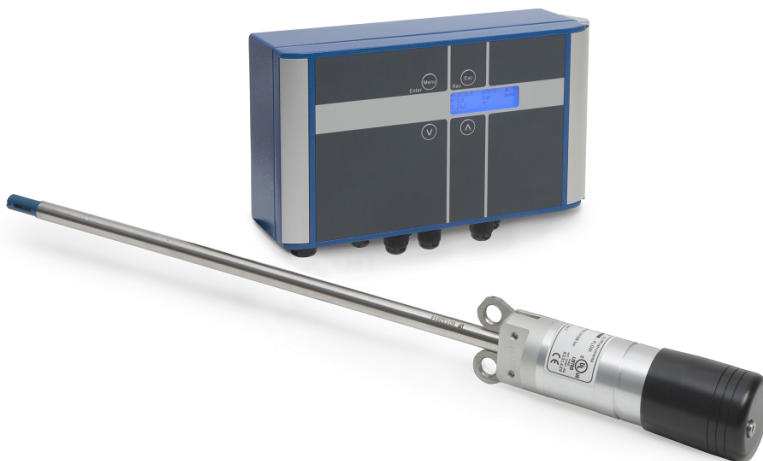

4 Quick start

This chapter contains the basic steps to start using your VPFlowTerminal. Additional information on all subjects can be found in the next chapters.

1. Unpacking

- Unpack the box and check if all items are there and in good shape. A checklist with all items is available on the box

2. Configuration

- Connect the VPFlowScope sensor to the connector cap of the VPFlowTerminal
- Power up the VPFlowTerminal and connect the USB cable to a computer
- Configure inner pipe diameter, log intervals, 4..20mA inputs and other required parameters with VPStudio

3. Mechanical installation

- See the user manual for the best point of installation for this product. Make sure that all specifications are met
- 4 holes are available to mount the VPFlowTerminal on the wall
- Install the VPFlowScope. Installation guidelines can be found in it's manual. Read this carefully

See chapter [mechanical installation](#) for more detailed information.

4. Electrical installation

- A cable for connecting the VPFlowScope is pre-assembled. Connect the connector cap to the VPFlowScope
- Apply 100-240 VAC to power up the device, the display will light up when power is applied

See chapter [electrical connections](#) for more detailed information.

5. Data recording

A data log session can be started by pressing the esc button and then enter. All parameters will be logged with the default logging intervals. These logging intervals can be changed with the VPStudio software. This software tool is also used to retrieve the recorded sessions

5 Mechanical installation

First select the right installation point. Make sure that the VPFlowScope is within range of the cable. It is not possible to extend the cable.

Follow the next six steps for installation.

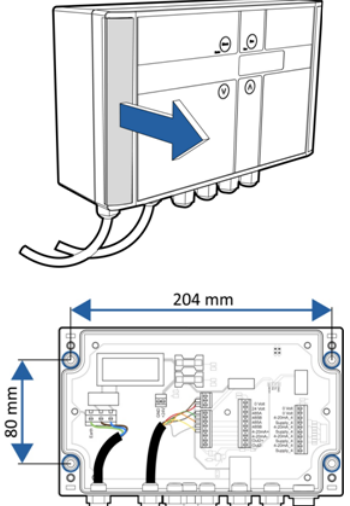
<p>1. Remove the silver strip at the left side by lifting it up with your fingernails and pull it towards you</p>	
<p>2. Remove the two screws and open the cover</p>	
<p>3. Hold the VPFlowTerminal at the preferred position on the wall and mark the four installation holes with a pencil</p>	
<p>4. Lay the VPFlowTerminal aside and drill the marked points</p>	
<p>5. Insert a jack in each hole</p>	
<p>6. Hold the VPFlowTerminal in front of the drilled holes and screw it through the connection holes to the wall</p>	



Do not install the VPFlowTerminal upside down



Do not install the VPFlowTerminal in an environment where fluids can leak onto the device



Do not drill through the installation holes, use a pencil to mark the position holes and drill afterwards

6 Electrical connections

	<p>Turn off power when the VPFlowTerminal is opened</p>
---	---

The VPFlowTerminal has a pre-assembled cable for the VPFlowScope. The VPFlowScope in-line with M12 8-pin connector can be connected to this cable directly. A connector cap with M12 8-pin connector is used to connect the VPFlowScope probe models. A VPFlowScope with 5-pin connector can not be connected.

A VPFlowScope needs to be connected to the VPFlowTerminal in order to work. It is not possible to use the VPFlowTerminal without the VPFlowScope connected.

To access the inputs and outputs of the VPFlowTerminal, the case needs to be opened. Make sure that it is tightened well to maintain the IP grade.

6.1 Connections

At the bottom of the VPFlowTerminal there are several connections as seen in the image below.

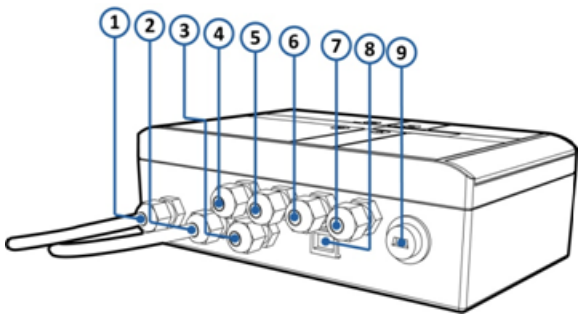
1. AC Mains inlet	
2. Cable with connector cap for VPFlowScope (pre-wired)	
3. Optional cable inlet/outlet for VPFlowScope RS485 bus.	
4. Analog input 1	
5. Analog input 2	
6. Analog input 3	
7. Analog input 4	
8. Ethernet connector for VPFlowScope	
9. USB connector	

6.2 Electrical overview

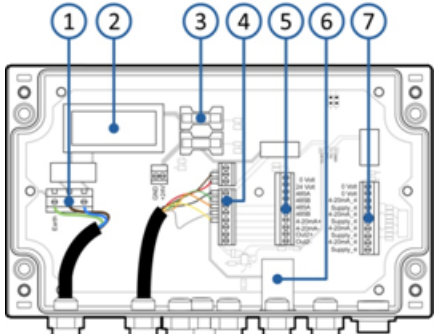
1. AC Mains screw terminal	
2. Power supply	
3. Secondary fuse (2x)	
4. VPFlowScope input screw terminal	
5. VPFlowScope output screw terminal	
6. RS485 Ethernet converter	
7. Analog input (4x)	

6.3 Connection to mains

Since April 2014, the VPFlowTerminal 5110 comes without power cord. A power cord with connector can be ordered separately, or a permanent power supply cable can be attached by a certified electrician.

VPInstruments supplies two types of power cords.

Order code	Description
VPA.2000.000	Power supply cable, 2m / 6.6ft, European power plug on side, open wires other side
VPA.2000.001	Power supply cable, 1.9m / 5.3ft, US power plug one side, open wires other side

Connecting the power

Always check all specifications, make sure all conditions are met. Installation to be performed by authorized electricians only.

The most left cable glands is intended for the mains power cable. The circuit board is equipped with a screw terminal for the power cord.

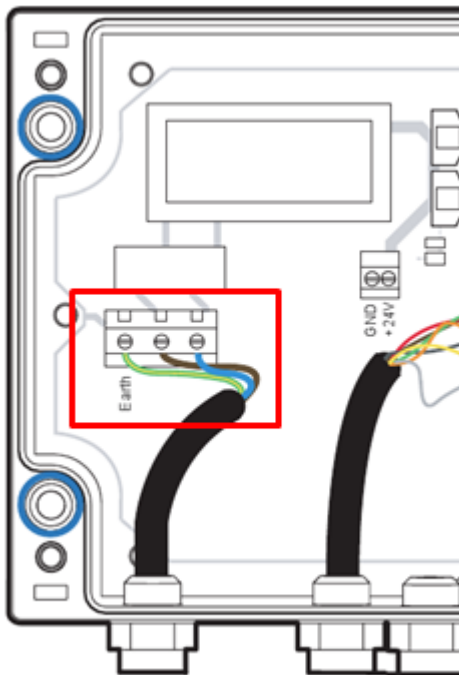

Figure: Connection example with European cable

VPInstruments power cord color codes:

Order code	Description	Neutral	Phase	Earth
VPA.2000.000	European plug	Blue	Brown	Yellow/Green
VPA.2000.001	Usa plug	White	Black	Green

6.4 VPFlowScope connections

VPFlowScope connection

The cable to the VPFlowScope is pre-wired. All signals are available on the middle screw terminal block. These signals can be used for connection to a building management system or Modbus chain.

RS485:

These terminals are available in pairs, and can be used for RS485 networking. Use twisted pair shielded cable, with two pairs. One pair for A and B, and one lead of the other pair to interconnect the 0 Volt wire.

4..20mA:

The 4..20 mA output of the VPFlowScope is Active, which means that the VPFlowScope powers the loop. For VPFlowScope only the 4..20 mA + is used. 4..20 mA - is not connected.

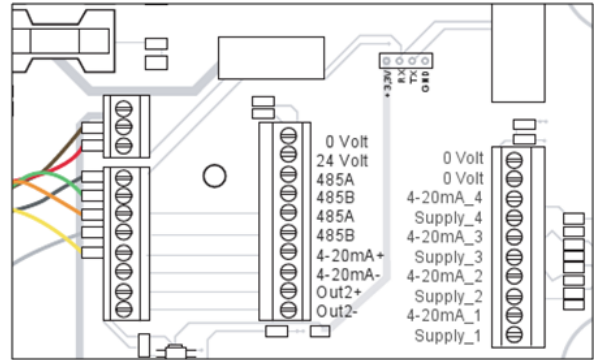

Pin	Signal
1	Rx
2	0 Volt
3	Tx
4	4..20 mA signal, active
5	RS485 A
6	RS485 B
7	Not connected
8	+12...24 VDC

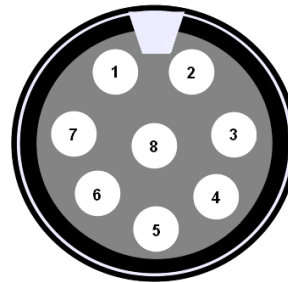

6.5 Analog inputs

Analog inputs

The VPFlowTerminal features 4 powered loop analog inputs. Each input has a 24V supply and a return input. The current signal is measured within this loop

If the analog sensor requires a separate power supply which means that it is not powered from the loop, the 0 and 24V outputs can be used. (150mA max)

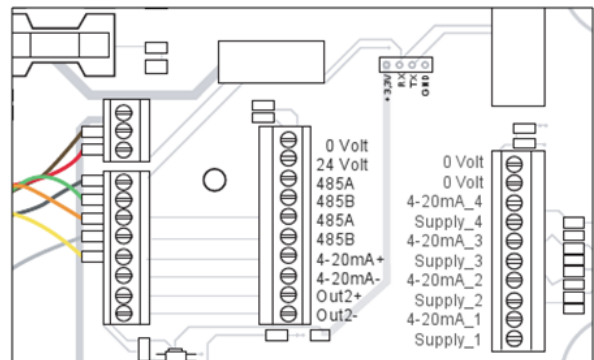

6.6 Ethernet converter

The VPFlowTerminal contains a built in Ethernet port. This port is based upon a Lantronix xport module. In order to use this port, it needs to be configured and assigned with an IP address. The application to configure the port can be downloaded from www.lantronix.com. Search for deviceInstaller in the download area.

Xport configuration

- Download and install deviceInstaller from the Lantronix website
- Power up the VPFlowTerminal and connect an Ethernet cable to your computer.
- Start deviceInstaller and click search. The Xport should be found.
- When the port is not listed, assign a fixed IP address to your computer
- Select the xport module and go to the tab "web configuration". Then click the green button to open the configuration window. Log in with username "admin" and leave the password form empty.

Addressing an IP address

Select the option "network" in the menu. Here you can adjust the network settings of the xport.

Setting the baud rate

The xport converts the RS485 signal from the VPFlowScope to Ethernet. Therefore, the xport needs to know what the communication parameters are. Click serial settings in the menu to change. Make sure that the settings match the VPFlowScope settings.

Other options

All other options for the xport are pre-configured and may not be changed. Changing these parameters may cause the converter to stop working.

Modbus communication

Once the port is installed, the VPFlowTerminal is ready to be used with Modbus. All VPFlowScope parameters are available according the VPFlowScope manual. Note that the signal is Modbus RTU over TCP. The analog inputs can not be read out by Modbus.

6.7 Schemes

Modbus (RS485)

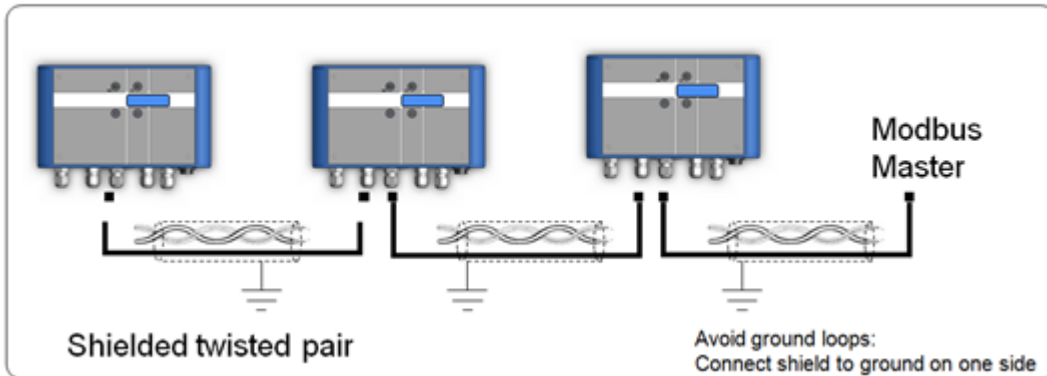

4..20 mA output VPFlowScope

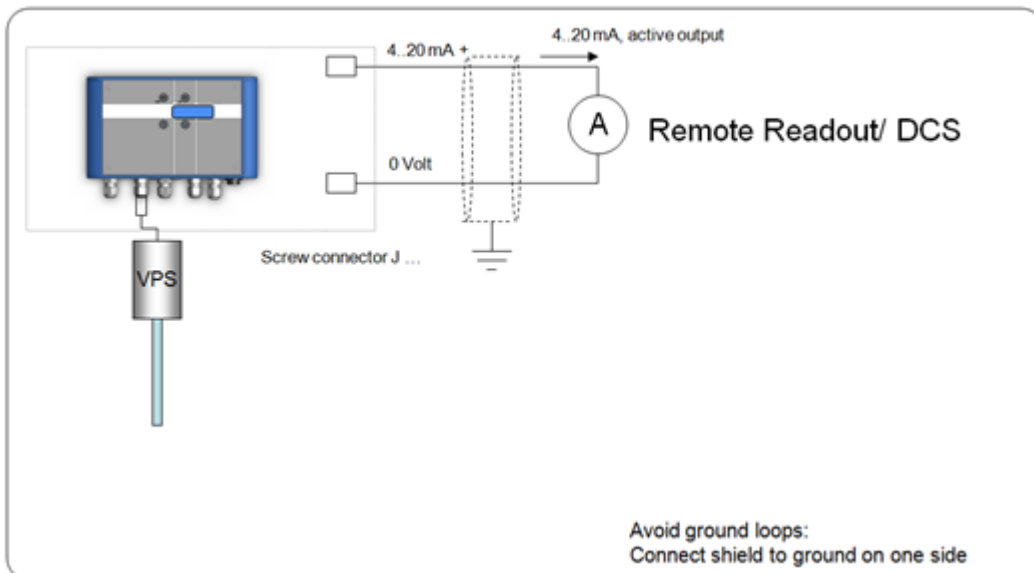

4..20 mA sensors

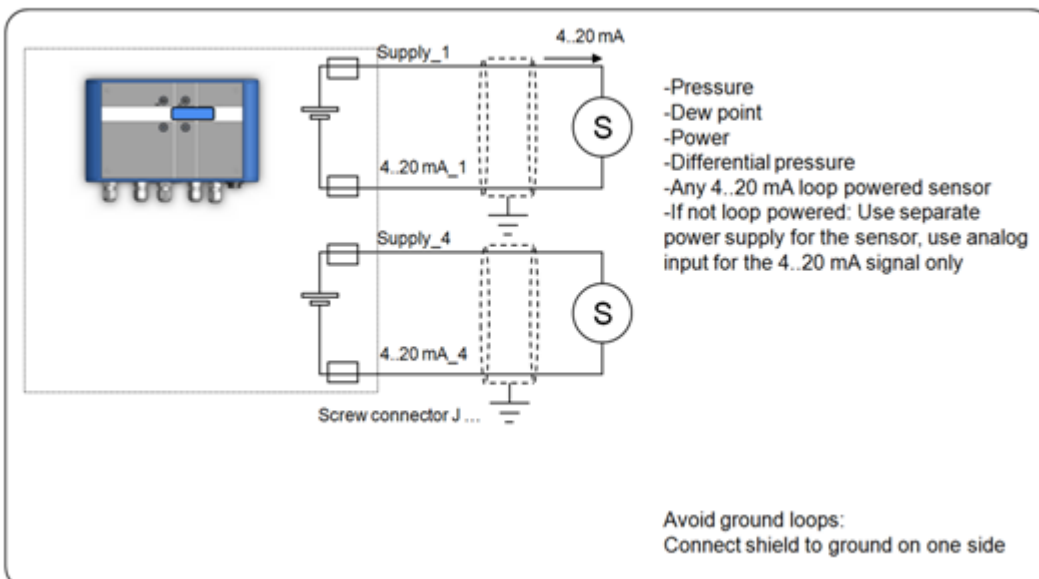







7 Display

The display is used for real time read out of the VPFlowScope sensor inputs and the analog signals. This chapter explains all functionality.

7.1 Display status icons

Some status icons show feedback on the meters' status. Below is a list with explanation

Icons	Description
	Sensor module is properly connected and supplied with power
	No communication with the sensor [Check external power when disconnected]
	A blinking dot will indicate that a data session is active
	2 rotating arrows indicate that there is communication with the computer
	The display is locked. The menu can not be accessed
	Memory indication. Each block indicates 20% of memory usage. The blocks start to blink if the memory is more then 95% full

7.2 LCD display

The LCD display provides 3 rows for real time data. Each row can be configured in the menu by selecting the desired parameter for this row. Available options are listed in [menu -> display](#).

7.3 Data Logger

The built-in data logger offers you 2 Million data points. Enough to measure all three channels 1 x per second for more than a week. A little warning though: more data does not always lead to better insight in savings! The analog inputs can also be stored in the data logger. The log interval for each input can be set with the VPStudio software.

Use the following guidelines for the intervals

Application	Flow	Pressure	Temperature
Standard energy management application	5 min	5 min	5 min
Machine testing - quick fluctuations	1 sec	1 sec	1 sec
Audit - one week	10 sec	10 sec	5 min
Audit - one month	30 sec	30 sec	5 min

Multiple sessions can be recorded. When a session is started, a separate session will be recorded. It's not possible to append to an existing session.

When a power failure occurs during recording, the session will be stopped. When power is restored, a new session will start automatically.

7.4 Keypad

The key pad contains 4 buttons to control the VPFlowTerminal

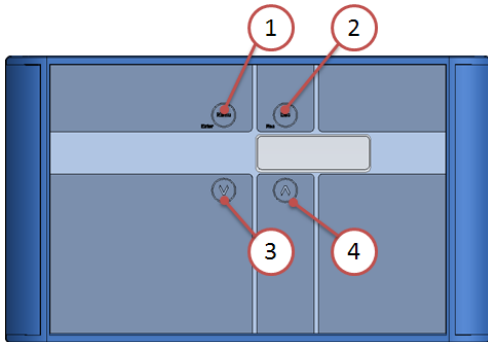

- | | | |
|---|-----------------|--|
| 1 | Menu / Enter | Used to enter the (sub)menu or to confirm a setting |
| 2 | Escape / Record | Will start a data logging session when in the data acquisition screen.
Will return from a (sub)menu when not in the data acquisition screen |
| 3 | Button down | Navigate down in the menu |
| 4 | Button up | Navigate up in the menu |

Special key functions

- Lock display
In the main screen, press up and down simultaneously to lock or unlock the display. A lock icon will appear in the right lower corner of the screen. The lock function will block keypad functionality.
- Clean re-boot.
Hold esc pressed when turning the power on. Use this option when a display will not start up or if a session won't stop. This can happen due to subsequent power failures at the moment that the memory is almost full.

7.5 Menu

The menu is categorized into 3 main items which contain their own sub menu items. The complete menu structure is shown below:

1. Settings
 1. Diameter
 2. Display
 3. Date and Time
 4. Modbus address
 5. Display dimtime
2. DAQ Sessions
 1. New Session
 2. Delete all
3. Advanced
 1. Reset

1 Settings

The settings menu can be used to change both functional parameters as display settings.

1.1 Diameter

The sensor needs to know the exact inner pipe diameter to calculate mass flow. Changing the diameter is only possible when the sensor is connected. When the menu is entered, first select the desired unit, this can be in mm or inch.

Now enter the inner pipe diameter and confirm by pressing enter

1.2 Display

The main screen of the display contains 3 rows to display measurement values. Via this menu measurement values can be assigned to these rows. Available options in the menu are:

Measurand	Available units	Description
Empty	-	Leave this display row empty
Flow	m _n /sec m ³ _n /h l _n /min CFM m ³ /min sfps	Flow values are normalized: 0 degrees C and 1013.25 mbar
Pressure	Bar Psi	Gauge
Temperature	Deg C Deg F	
Totalizer	m ³ _n	Flow values are normalized: 0 degrees C and 1013.25 mbar
Analog inputs [1..4]		Analog inputs can be enabled and configured with VPStudio
Custom		5 available units to be configured with VPStudio. Multiply an existing unit with a user defined factor.

1.3 Date and Time

Adjust date and time settings. First enter the menu option and set the date with the key pad. The date is formatted as: DD-MM-YYYY. After setting the date, confirm with enter and then enter the time settings in format: HH:MM:SS, again confirm with enter. The new date will become active immediately.

Date/time settings are kept actual by the real time clock until long power down. Date and time will also be synchronized with the computer when used with VPStudio.

1.4 Modbus address

The Modbus address can be changed with this menu option. Use the up and down buttons to change the number. Available numbers 1 – 247.

After setting the number press enter to save the address. The power of the attached VPFlowScope needs to be cycled to activate the new address.

1.5 Display dimtime

The display backlight dimtime can be adjusted here. The default dimtime is set to 10 seconds. Other Available options are:

- Fading off. The backlight will remain on
- 5 till 30 seconds with steps of 5 seconds

Confirming with menu will make this setting immediately active.

2 DAQ Sessions

The VPFlowTerminal contains a 2 Million point datalogger. Via this menu you can start and stop the sessions or delete all present data.

2.1 Start session

The session will be started when you push the enter button after selecting this option. When the session is started, the menu will close and the main screen will be shown. A blinking dot in the right upper corner will indicate the running session. The menu will be blocked when a session is active. The session can be stopped by pressing the esc button.

2.2 Delete all

All sessions will be deleted. It is not possible to delete just a single session.

3 Advanced

3.1 Reset

Reset the device. All peripherals will be reinitialized. This option is also needed when updating the display firmware. Note: The Ethernet port and VPFlowScope sensor are not reset during this sequence.

8 VPStudio software

The VPFlowTerminal and its attached sensor can be read out and configured with the VPStudio software. This software can be downloaded from www.vpinstruments.com.

In case of basic configuration and read out, use the free edition. If real time logging is required, request a license code by our sales department.

A quick start is shown below, read the VPStudio manual for more information. This manual can be downloaded from www.vpinstruments.com/downloads

Connect the VPFlowTerminal to the computer

The VPFlowTerminal can be connected to the computer with the USB connector. You can only download data log sessions and configure the display. For configuration or read out of the sensor the mains cable needs to be connected power up the attached sensor.

Install USB drivers

A driver needs to be installed for the USB interface. The driver might be installed automatically by your windows system or need to be installed manually. All drivers are available on our website www.vpinstruments.com/downloads.

Configure the VPFlowTerminal

- Start the VPStudio software
- In the left white window, right click to open the menu. Now click add device
- Click the scan button to search for the right COM port. Select it and click add
- Enter a name for the device
- Select USB
- Click add

VPFlowTerminal display read out

- Click on the terminal icon to read out the display settings
- The status tab provides general information
- The installation tab is used to configure the settings
- Click sessions below display to retrieve session data

VPFlowScope sensor read out

- Click on the plus symbol to unfold the sensor option
- Click on the sensor icon to read out the sensor settings
- The status tab provides general information
- The installation tab is used to configure the settings

9 Service

The VPFlowScope attached to your VPFlowTerminal needs regular maintenance to ensure that the product is functioning properly. Especially when the product is used for mobile air audits, we recommend inspecting the instrument before and after every audit to ensure that the product has not been damaged. For precision measurement equipment such as the VPFlowScope, a proper maintenance program is key to reliable measurement results and a long product lifetime.

9.1 Software and firmware updates

News on software and firmware updates can be found on www.vpinstruments.com, or are provided by your local re-seller. The USB interface is used for updating the firmware of the VPFlowTerminal. Instructions on the update procedure can be found in a separate instruction leaflet, which is distributed on request. Upgrading is only possible for authorized technicians, at own risk.

9.2 Calibration interval

The quality of the compressed air or gas you are measuring could influence the accuracy of this product. VPInstruments guarantees the accuracy, as indicated on the calibration certificate or in the product specifications. This accuracy will remain valid until the moment of commissioning within the first 36 months after purchasing this product under the following conditions:

- The products is stored indoors in a dry, frost free environment.
- Vibrations and heavy shocks should be avoided during transport and storage.

If this product is not commissioned within 36 months after the initial purchase we highly recommend to send the product back to VPInstruments for check-up and re-calibration.

Once the product is put into operation, the calibration interval depends on the quality of the gas. If the quality of the gas is unknown, VPInstruments advises annual recalibration. The latest calibration date can be found in VPStudio.

9.3 Service subscriptions

VPInstruments offers several Service Subscriptions. Enrolling in a Service Subscription helps you get the most out of your measurement equipment. We keep your equipment in excellent and most reliable condition, as we include annual re-calibration on our state of the art calibration equipment. With the latest software releases and expert technical support, you will save time and money. We offer the following programs:

- Standard Service Agreement; Cleaning. Re-calibration, repair*, firmware update(s) and warranty extension when serviced within 12 months subsequent intervals.
- Service Exchange Agreement; Annual exchange of your flow meter. No service time! Have a fully calibrated flow meter 24/7, 365 days a week!

* *Repair within terms of usage, see general terms and conditions.*

The VPInstruments service subscriptions helps keeping you focused on what matters most for your company.

Benefits

- Annual calibrated and cleaned instruments
- Warranty extension
- Software- and firmware updates
- Personal (phone) support and e-mail support by our skilled technicians

Consult your distributor for the best VPInstruments service agreement for your business.

10 Specifications



Please always check the label of your product for the specifications.
Specifications are subject to change as we are continuously improving our products.
Please contact us to obtain the latest specification sheet.

Mechanical

VPT.5110.000	230mm x 130mm x 75mm	1.6 Kg
Housing	Painted Aluminum	IP65
Ambient temperature	0..50°C	32 .. 122°F

Electrical

Power supply	100 - 240 VAC
Primary fuse	1 Ampere
Secondary fuses	250 mili Ampere

Display

Technology	Liquid crystal
Back light	Blue with auto power save
Memory	2 Million point memory

Inputs and outputs

Analog output	VPFlowScope current / pulse output
Analog inputs	4 x 4..20mA input, 25mA max
Serial IO	Modbus RTU
	USB for configuration
Ethernet	Lantronix Xport converter for RS485

11 Order information and accessories

VPT.5110.000	VPFlowTerminal
VPS.R150.P400.VPT.KIT	VPFlowterminal with VPFlowScope, probe length 400mm
VPS.R150.P600.VPT.KIT	VPFlowterminal with VPFlowScope, probe length 600mm
VPS.R150.P4DP.VPT.KIT	VPFlowterminal with VPFlowScope dP, probe length 400mm
VPS.R080.M050.VPT.KIT	VPFlowTerminal with VPFlowScope in-line 0.5"
VPS.R250.M100.VPT.KIT	VPFlowTerminal with VPFlowScope in-line 1"
VPS.R01K.M200.VPT.KIT	VPFlowTerminal with VPFlowScope in-line 2"

Accessories

VPA.5001.901	Connector cap with M12, 8 pin socket. For VPFlowScope (dP) sensor module in combination with VPFlowTerminal
VPA.5000.002	Pre-mounted cable, length 20m / 64.8ft
VPA.2000.000	Power cable, 1.9m / 6.3ft with EU plug on one side

VPStudio software

SFT.5003.100	Free edition
SFT.5003.300	Licensed edition

4..20mA Sensors

VPA.8000.2100	VPLog-i AC current sensor 100A-rms
VPA.8000.2200	VPLog-i AC current sensor 200A-rms
VPA.8000.2400	VPLog-i AC current sensor 400A-rms
VPA.8000.2800	VPLog-i AC current sensor 800A-rms
VPA.8000.21K5	VPLog-i AC current sensor 1500A-rms
VPA.8000.1014	Dew point sensor 1/2" BSP -60 to +40°C / -76 to +104°F 4..20mA
VPA.8000.1317	Dew point sensor 1/2" NPT -60 to +40°C / -76 to +104°F 0..10V
VPA.8000.1017	Dew point sensor 1/2" NPT -60 to +40°C / -76 to +104°F 4..20mA
VPA.8000.1003	Dew point sensor 5/8" UNF -100 to +20°C / -148 to +68°F 4..20mA
VPA.8000.1020	Pressure sensor 0-16 bar abs BSP thread
VPA.8000.1030	Pressure sensor 0-16 bar abs NPT thread

12 Appendix A - Connection examples

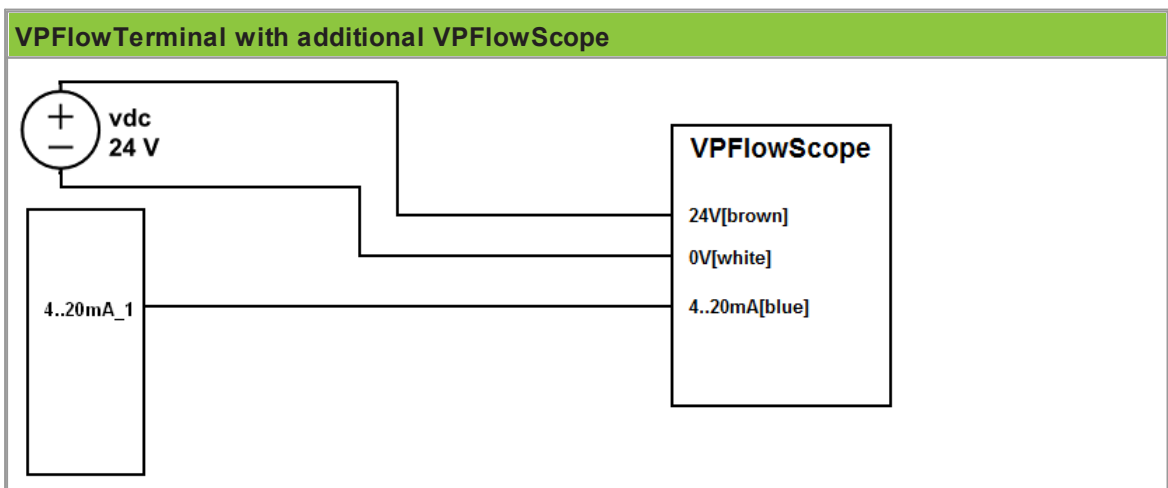
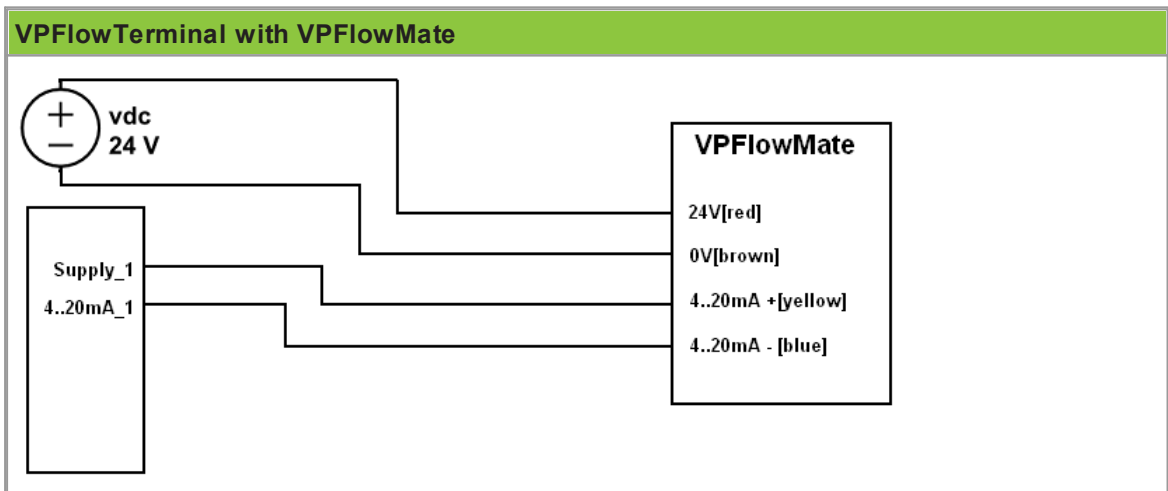
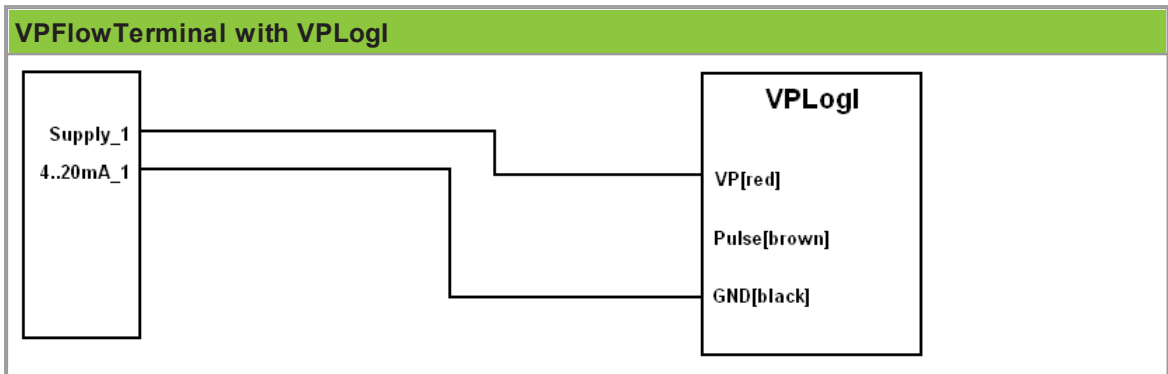

13 Appendix B - Zero and Span calculation

Configuration of the VPFlowTerminal for analog inputs

You need to configure the VPFlowTerminal via your personal computer, using VPStudio software.

There are three things to configure:

- The name and prefix of the sensor
- The logging interval for the sensor
- The 4..20 mA scaling for the sensor

Current to power calculation

In this example we will explain how to calculate the power corresponding to the 4..20 mA output value. Before we can do this we need some more data.

1. Measure the supply Voltage (! remember, this is a task for certified electricians)
2. Check the power factor of your motor. The power factor will be a number between 0.7 and 0.9, and is assumed to be constant.

The formula to calculate the power is as follows, for a three phase motor:

$$P(kW) = \frac{I (\text{Ampere}) * U (\text{Volt}) * \cosinus(\varphi)}{\sqrt{3}} * 3 * \frac{1}{1000}$$

This formula can be simplified:

$$P(kW) = I (\text{Ampere}) * U (\text{Volt}) * \cosinus(\varphi) * \sqrt{3} * \frac{1}{1000}$$

Lets assume a $\cosinus(\varphi)$ of 0.7

For a 200 Amp current clamp, the Pmax (maximum power) is:

$$P_{max} = 200 * 400 * 0.7 * \sqrt{3} * \frac{1}{1000} = 97kW$$

This number will correspond to 20 mA and this is the number to fill as span value.

0 kW will correspond to 4mA as this is the current level when there is no power being consumed.

This number can be filled in as zero value

So now you have configured all input you need. You can start logging now.

Setting the logging interval

The logging interval depends on what you would like to see. If you are interested in control system behavior, you can set the logging interval to 1 second, and measure for a couple of days. If you would like to see slow variations, for example the influence of daily production on the performance, you can set the interval to once per minute. For see seasonal influence, a 15 minute interval provides enough data to make the right analysis.



TIP: For flow, pressure and kW, we recommend to have identical intervals.

EASY INSIGHT IN ENERGY FLOWS

VPInstruments

Buitenwatersloot 335
2614 GS Delft
The Netherlands
info@vpinstruments.com
www.vpinstruments.com

MAN-VP-T51-UK-1700

Date: 16-02-2017



INSTRUMENTS